

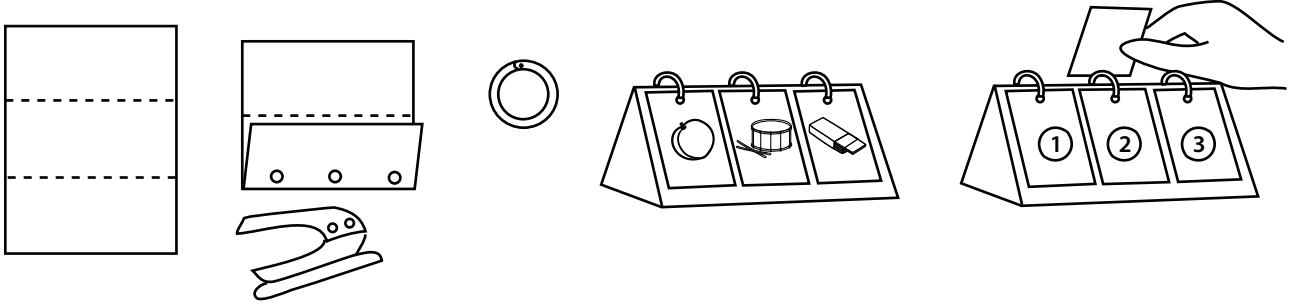



# Flip Books: Rhyming Words Match

You need: construction paper, loose leaf rings, hole punch

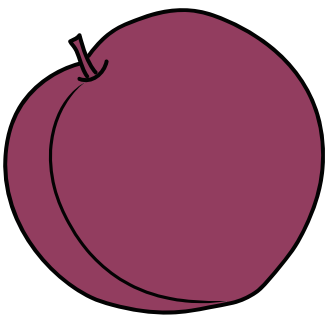
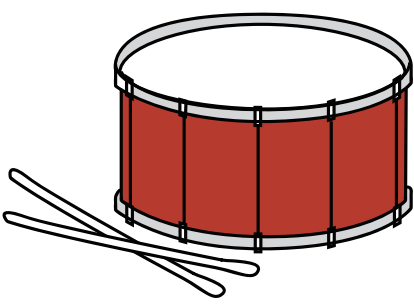

 <p>○</p> <p>①</p>	 <p>○</p> <p>②</p>	 <p>○</p> <p>③</p>
 <p>○</p> <p>①</p>	 <p>○</p> <p>②</p>	 <p>○</p> <p>③</p>

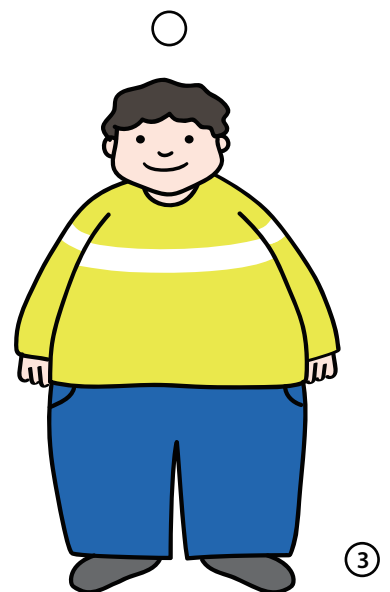
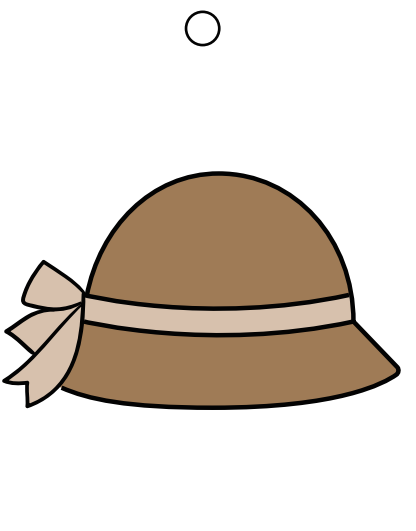
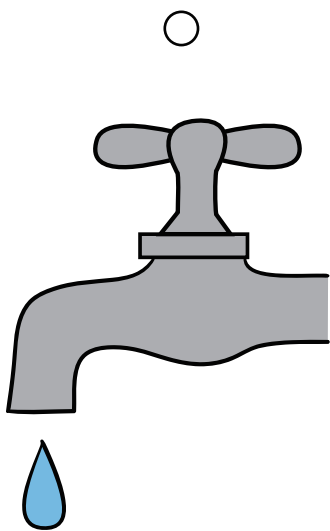
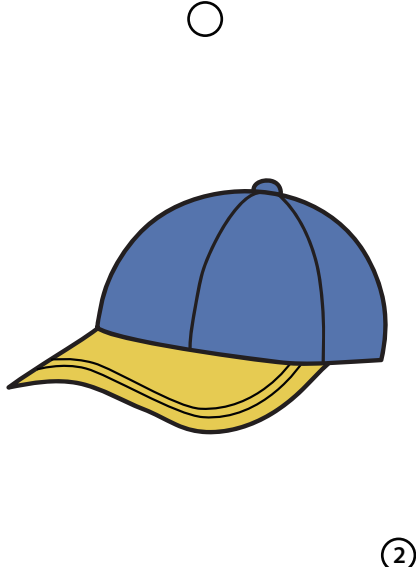
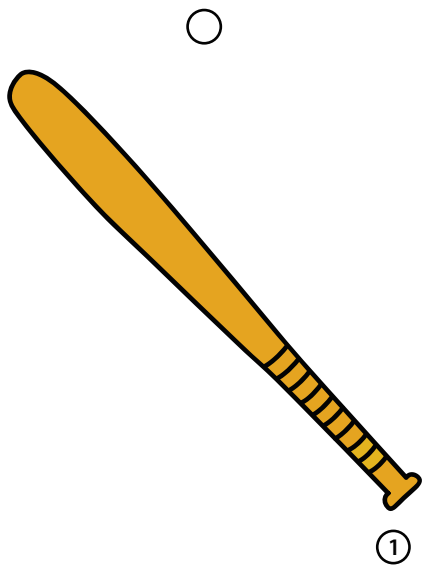
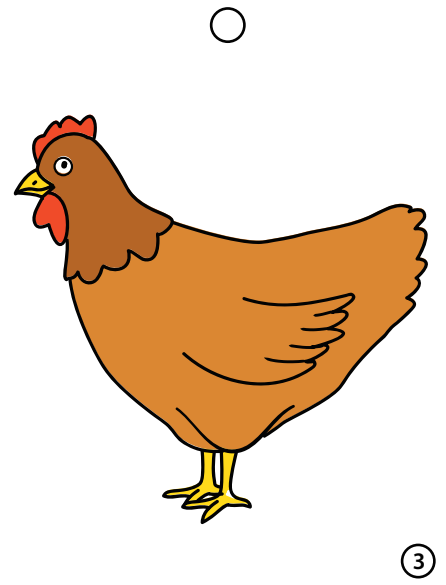
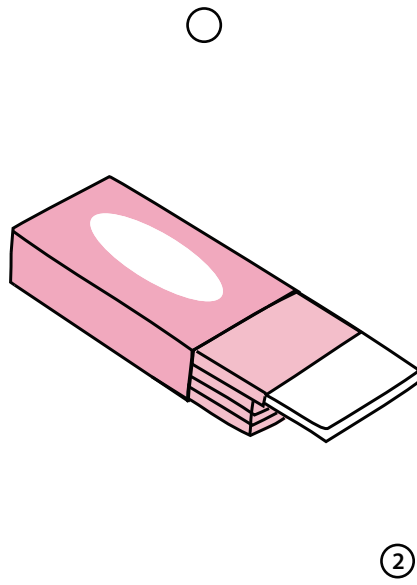
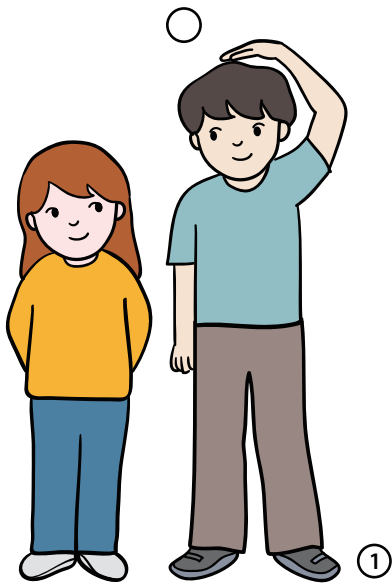

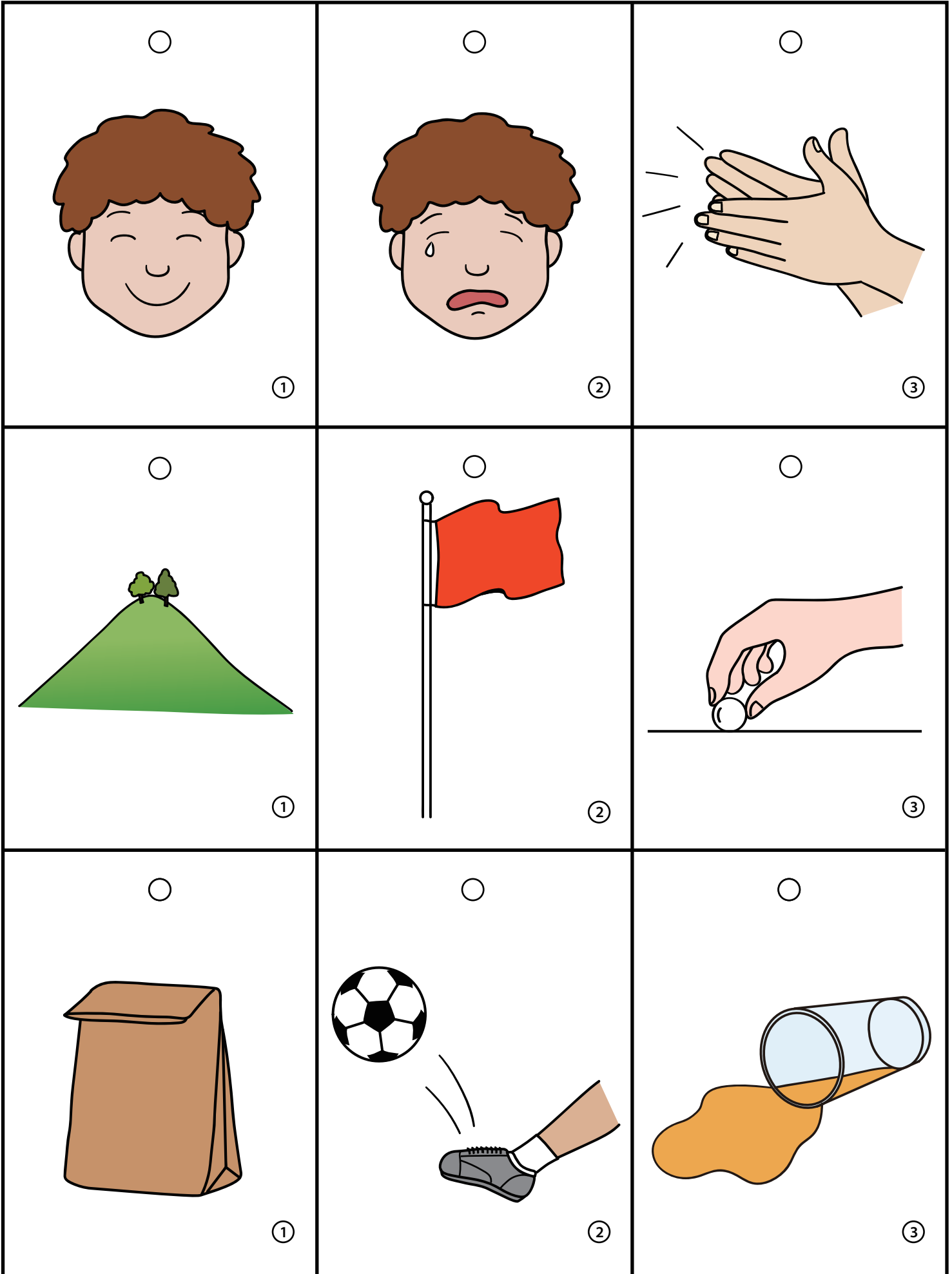

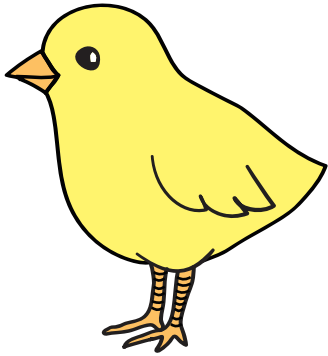

①

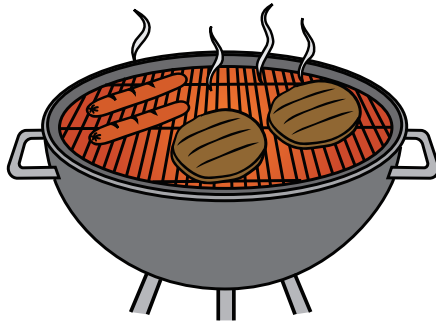

②

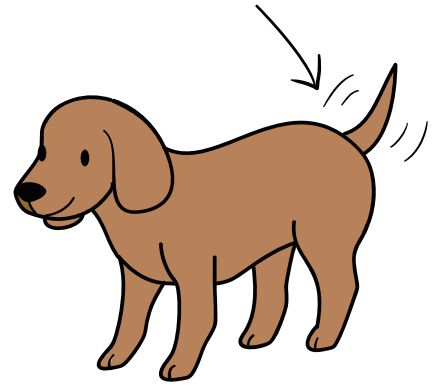

③

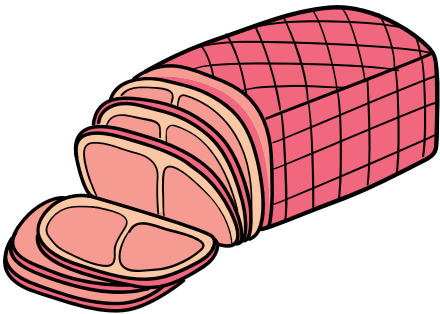

①

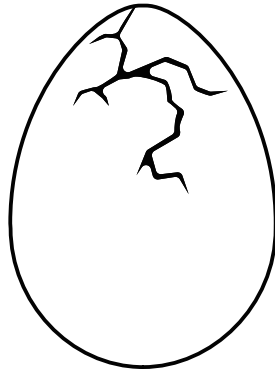

②



③

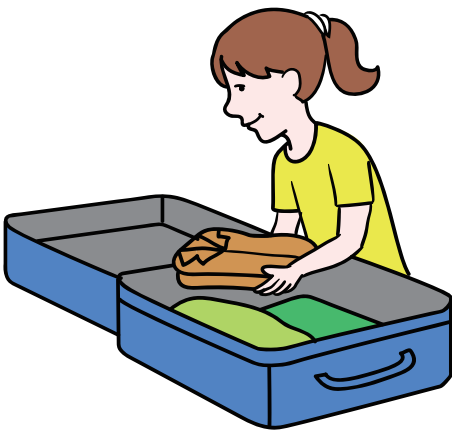

①

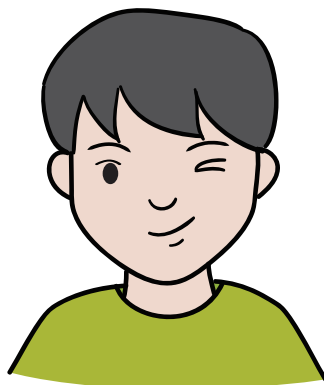

②

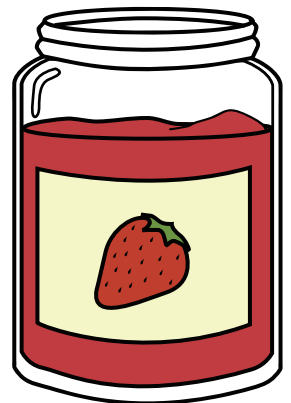

③

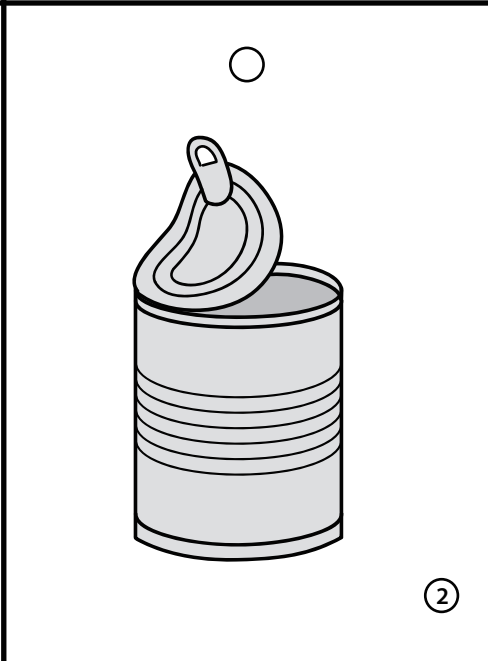
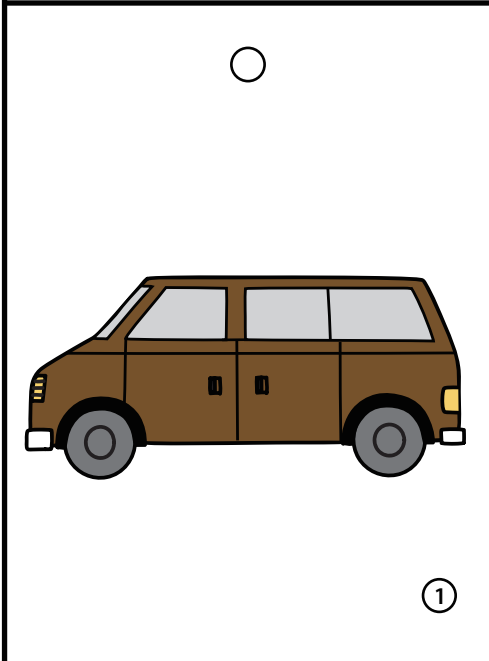
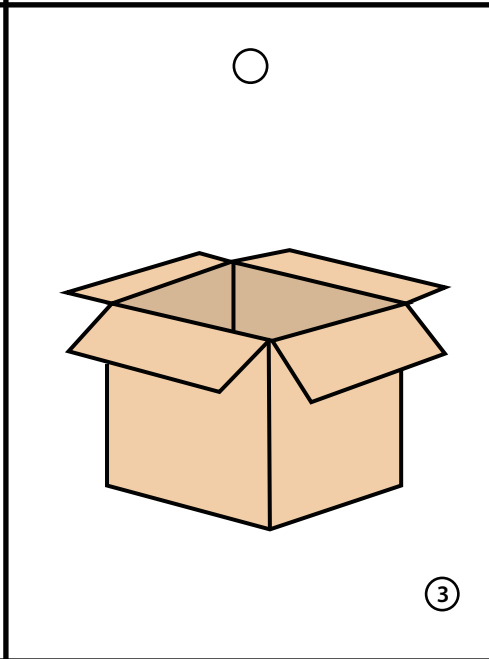
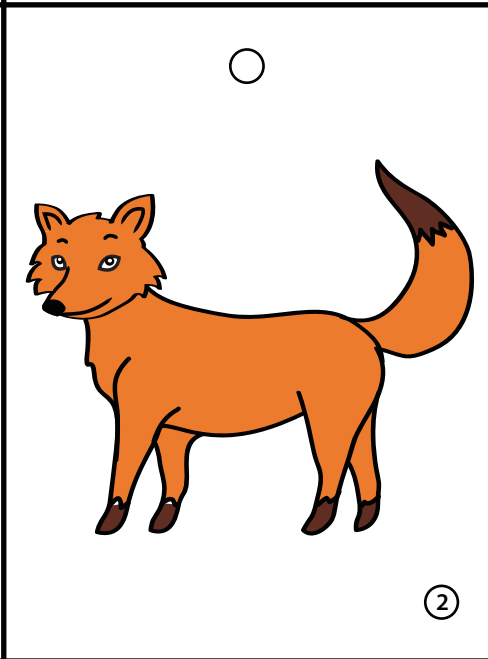
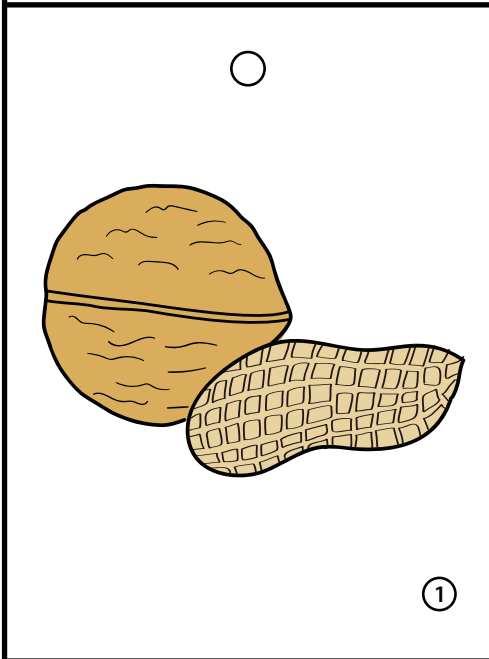
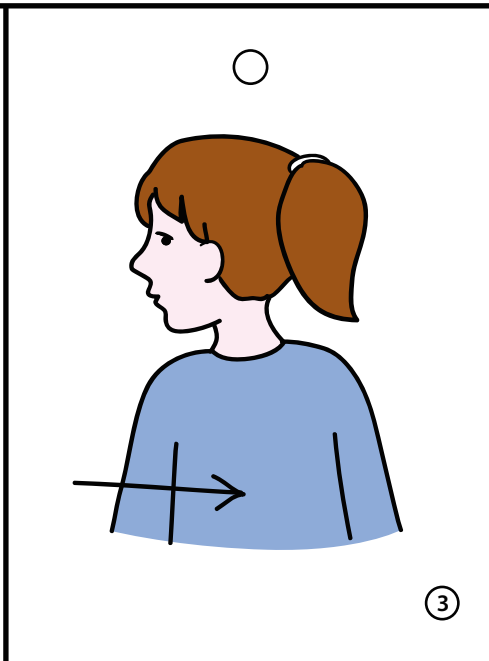
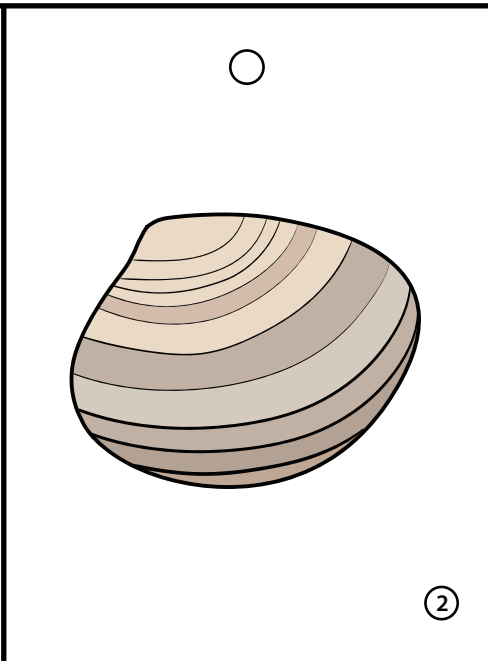
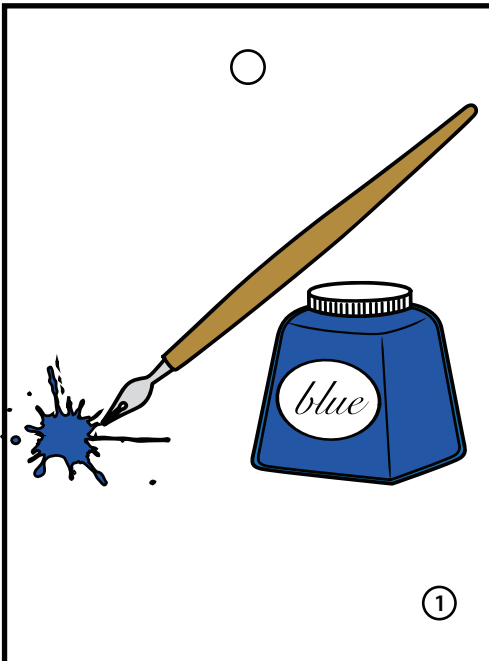

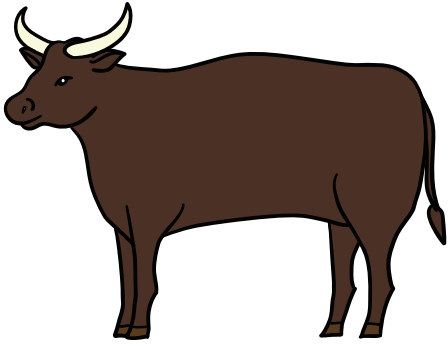

①

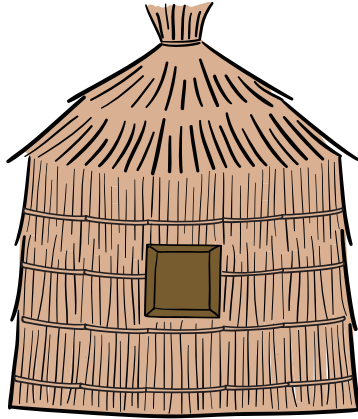

②

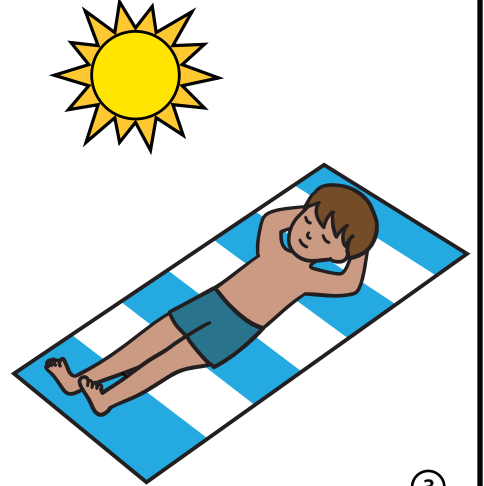

③

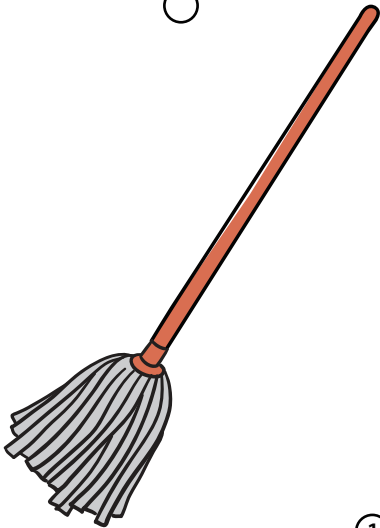

①

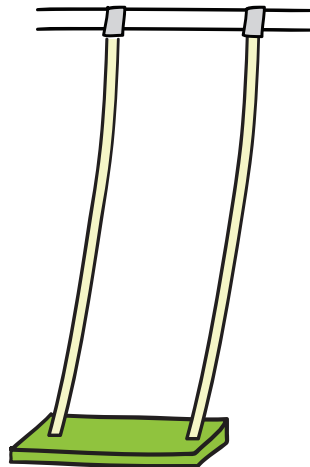

②

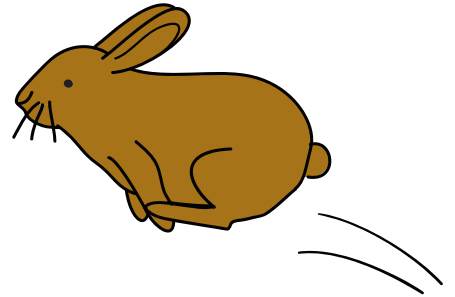

③

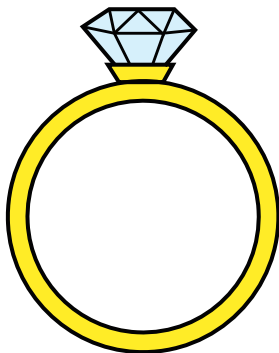

①

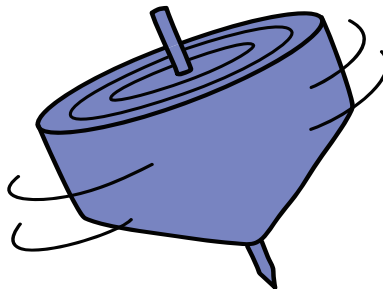

②



③

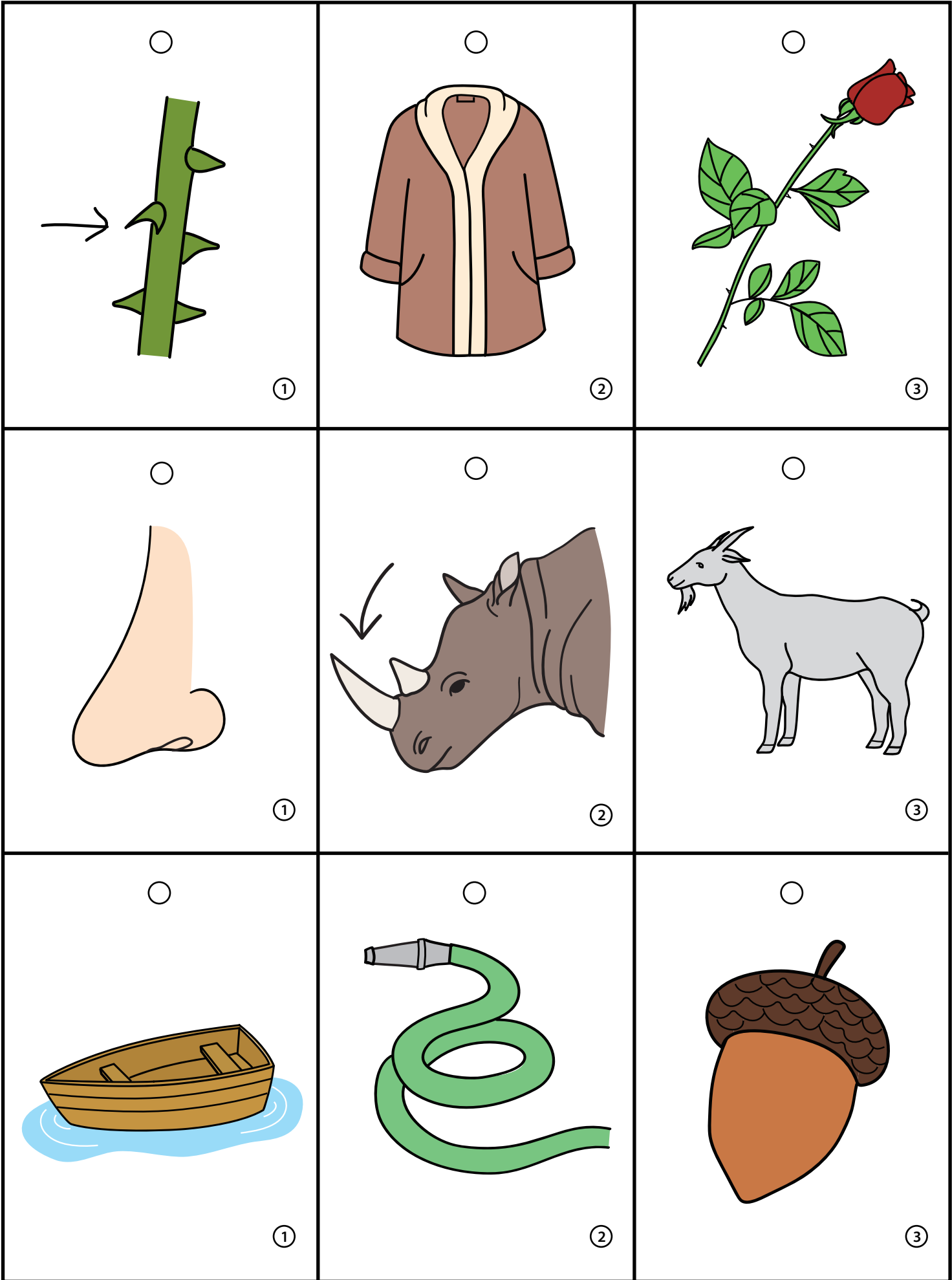



①

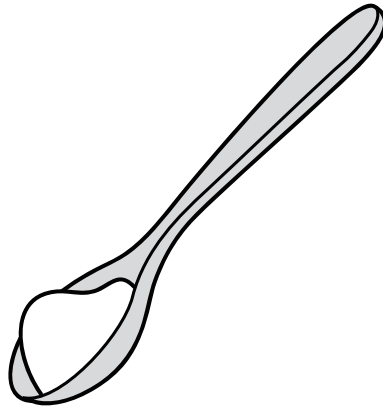

②

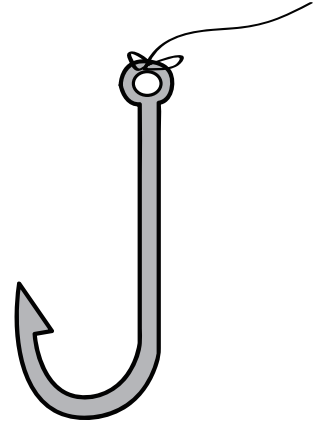

③

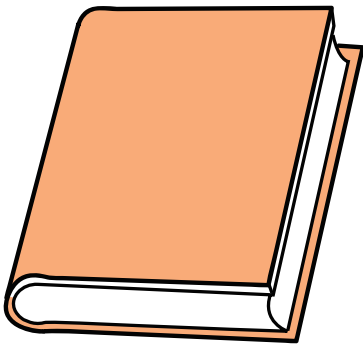

①

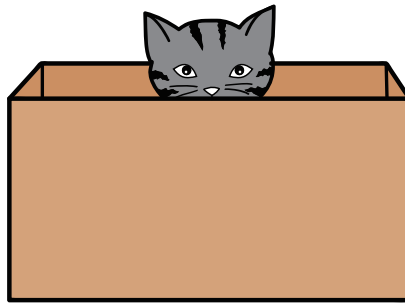

②



③

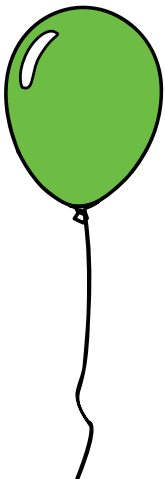

①



②



③



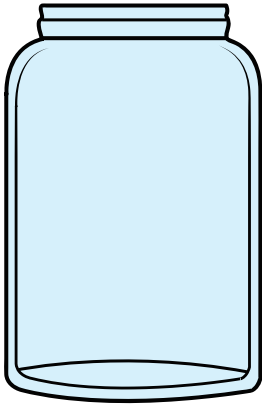

①



②

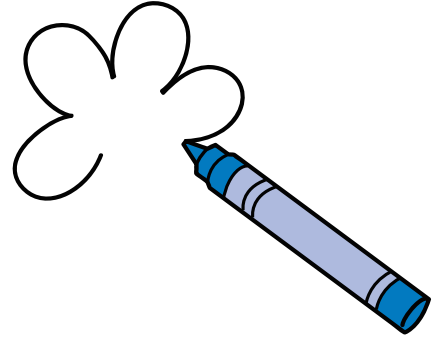

③

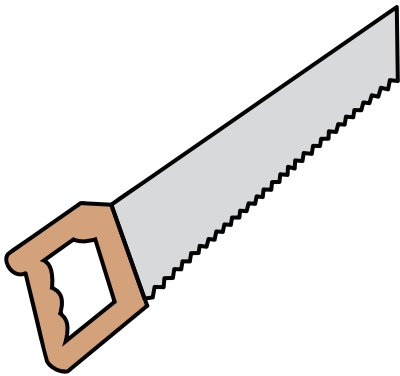

①



②

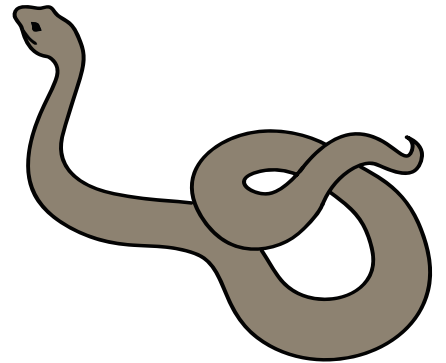

③



①

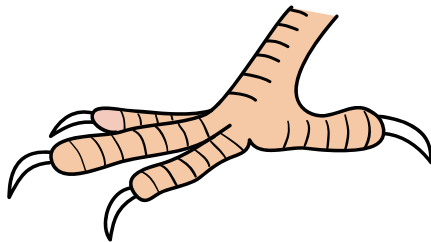

②

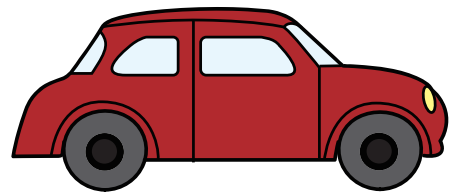

③

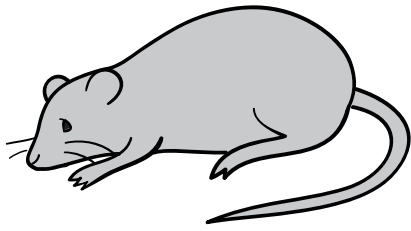

①

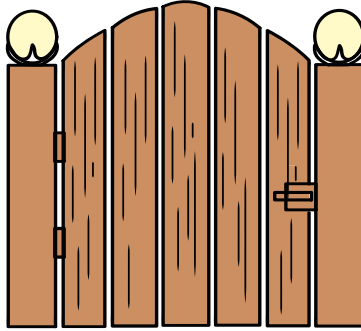

②

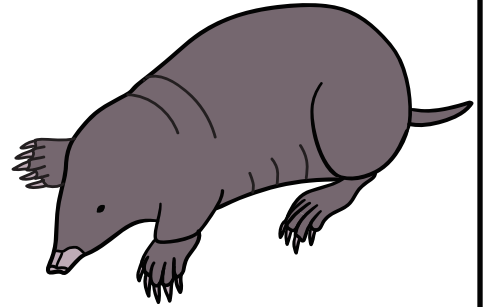

③



①



②

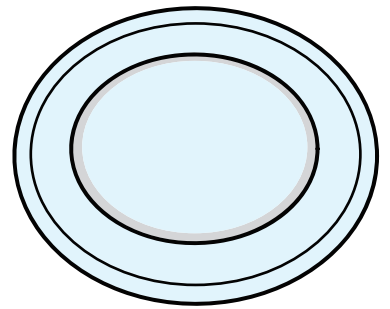

③

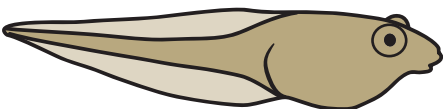

①

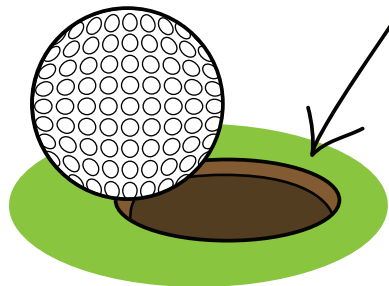

②



③

# Flip Books: Rhyming Words Match

You need: construction paper, loose leaf rings, hole punch

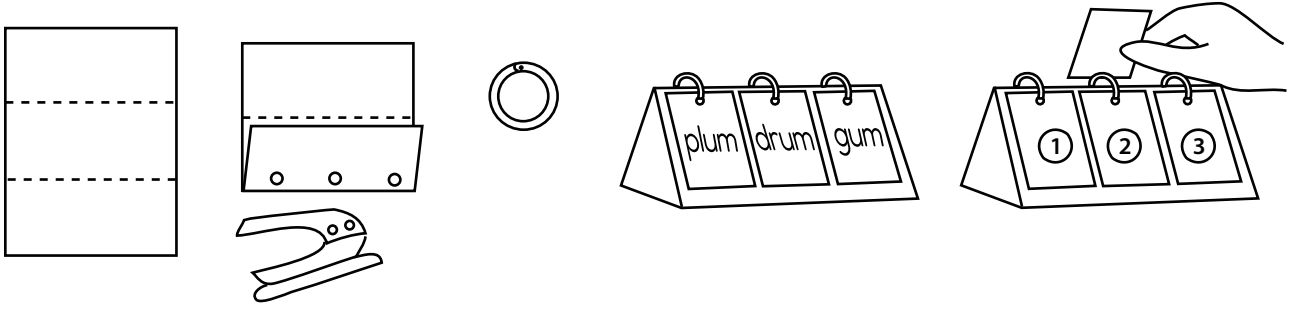

<p>○</p> <p>pen</p> <p>①</p>	<p>○</p> <p>ball</p> <p>②</p>	<p>○</p> <p>plum</p> <p>③</p>
<p>○</p> <p>drum</p> <p>①</p>	<p>○</p> <p>ten</p> <p>②</p>	<p>○</p> <p>fall</p> <p>③</p>



tall

①



gum

②



hen

③



bat

①



cap

②



mad

③



tap

①



hat

②



fat

③



glad

①



sad

②



clap

③



hill

①



flag

②



pick

③



bag

①



kick

②



spill

③



chick

①



grill

②



wag

③



ham

①



crack

②



sink

③



pack

①



wink

②



jam

③



ink

①



clam

②



back

③



nut

①



fox

②



box

③



van

①



can

②



donut

③

○  
ox

①

○  
hut

②

○  
tan

③

○  
mop

①

○  
swing

②

○  
hop

③

○  
ring

①

○  
top

②

○  
king

③





thorn

①



coat

②



rose

③



nose

①



horn

②



goat

③



boat

①



hose

②



acorn

③



slide

①



spoon

②



hook

③



book

①



hide

②



moon

③



balloon

①



cook

②



ride

③



jar

①



cake

②



draw

③



saw

①



star

②



snake

③



rake

①



claw

②



car

③



mouse

①



gate

②



mole

③



skate

①



blouse

②



plate

③



tadpole

①



hole

②



house

③